

# CDM-ISO-ELEVATOR



## Resilient elements for elevators

Lifts and elevators often transmit noise and vibration to adjacent spaces causing disturbance to the occupants of the building. **CDM-ISO-ELEVATOR** is a range of vibration isolation and decoupling products and systems that minimise the levels of noise vibration transmitted to the building.

Each system is designed to meet project specific requirements and criteria. The resulting overall system will provide the best possible noise and vibration comfort conditions for both the people in the lift and the occupants of the building.

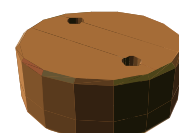
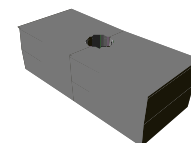
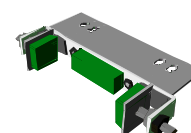
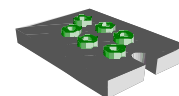
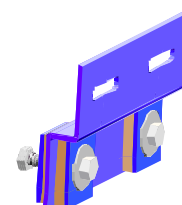
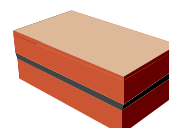
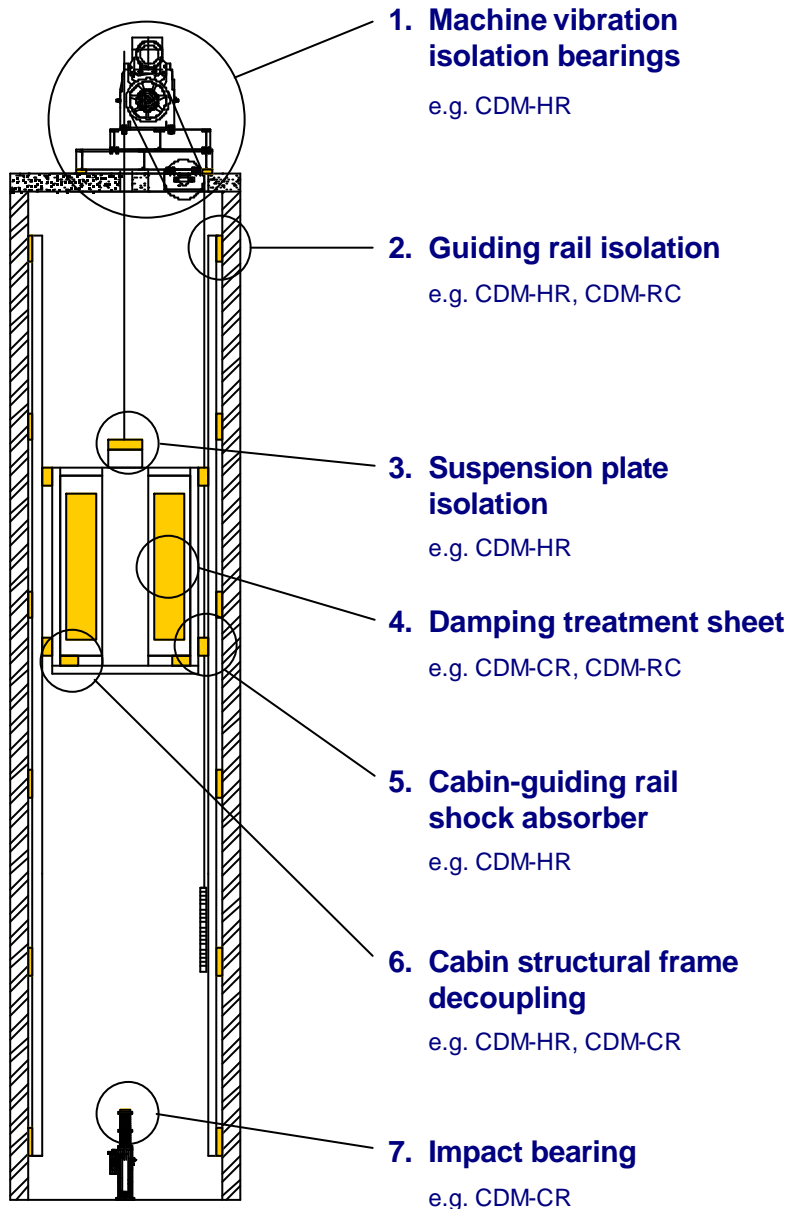

Some of our customers: Otis, Kone, Ebel, Thyssen, Sodimas, Soulier, Elevadores Sûr,...

## CDM-ISO-INDUSTRY

CDM-UK  
PO Box 7035  
Melton Mowbray  
Leics LE13 1WG



noise & vibration control

T: + 44 (0) 1664 482486  
F: +44 (0) 1664 482487  
E: info@cdm-uk.co.uk  
www.cdm-uk.co.uk